

RELAÇÃO DO AÇO

P18-L3	P18-L3
P19-L3	P19-L3
P20-L3	P20-L3
P21-L2	P21-L2
P22-L2	P22-L2
P23-L2	P23-L2
P24-L1	P24-L1
P25-L1	P25-L1
P26-L1	P26-L1
P27-L1	P27-L1
P28-L1	P28-L1

AÇO	N	DIAM	Q	UNIT	C-TOTAL
60	1	5.0	35	129	4515
	2	5.0	70	36	2520
	3	5.0	269	69	1871
	4	5.0	42	11	400
	5	5.0	480	31	15190
	6	5.0	203	159	32277
	7	10.0	4	78	312
	8	10.0	28	318	8268
	9	10.0	4	358	1432
	10	10.0	80	VAR	4000
	11	12.5	64	VAR	23488
	12	12.5	64	VAR	23488
	13	12.5	58	VAR	21430
	14	12.5	6	VAR	234
	15	12.5	6	VAR	234
					564

RESUMO DO AÇO

AÇO	DIAM	C-TOTAL	PESO+10%
CA50	10,0	146,8	89,6
CAB0	12,5	392,5	416,2
CAB0	3,0	807,4	136,8
PESO TOTAL			
CA50		515,8	
CAB0		136,8	

Vol. de concreto total = 56,82 m³
 Área de forma total = 65,74 m²

PROJETO PADRÃO - FNDE

MUNICÍPIO - UF:

PROPRIETÁRIO:

ENGENHEIRO:

PROPRIETÁRIO

RESP. TÉCNICO

CREA

RA

OBSERVAÇÕES:

QUADRA COBERTA
 PROJETO ESTRUTURAL

ESTRUTURA DE CONCRETO
 PILARES (P22 ao P30)

CONCORDADO	PROJETO	PROJETA	PROJETA
ESTRUTURAL	ESTRUTURAL	ESTRUTURAL	ESTRUTURAL
FORMADO	FORMADO	FORMADO	FORMADO
DATA: 11/25	DATA: 11/25	DATA: 11/25	DATA: 11/25
ASSINATURA	ASSINATURA	ASSINATURA	ASSINATURA
ASSINATURA	ASSINATURA	ASSINATURA	ASSINATURA

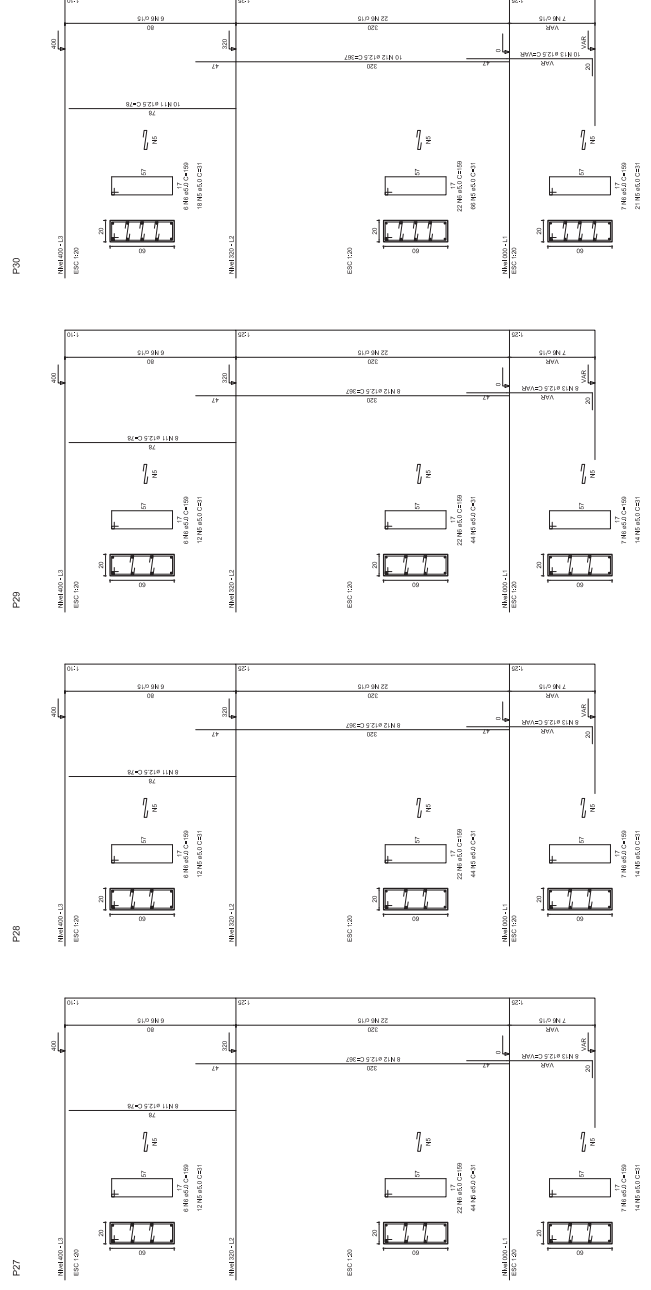
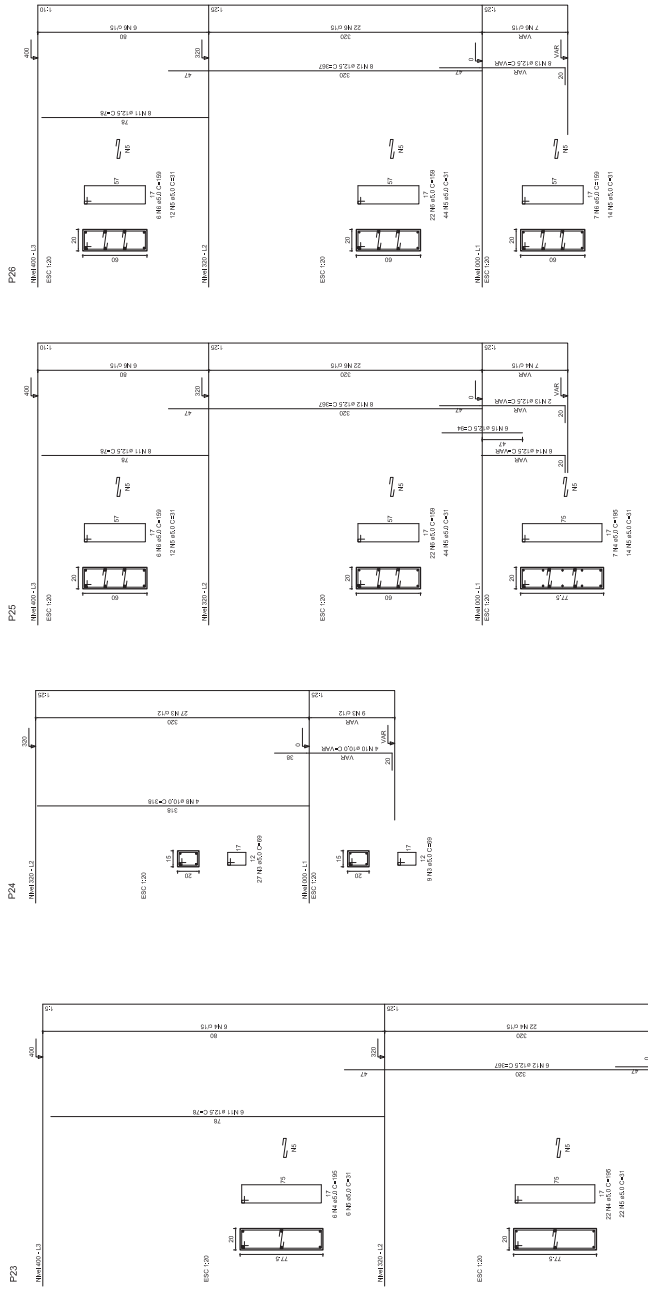

P18-P1 (Set 17#P20#P21#P24)

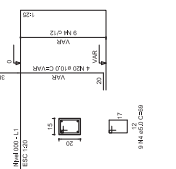

P22

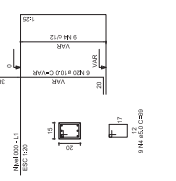

P10

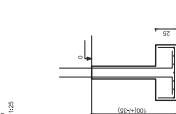

P18-P18 (Set 1#P12#P14#P19)

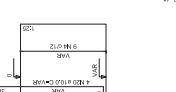

S18-S18

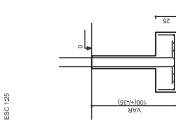

P18-P18

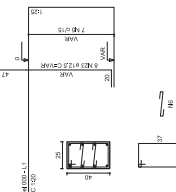

S18-S18

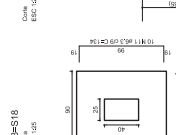

RELAÇÃO DOADO

PROJ	N	EMV	D	DATA	CL. DO AL.	PROJ
001	1	1	1	1	1	1
002	2	2	2	2	2	2
003	3	3	3	3	3	3
004	4	4	4	4	4	4
005	5	5	5	5	5	5
006	6	6	6	6	6	6
007	7	7	7	7	7	7
008	8	8	8	8	8	8
009	9	9	9	9	9	9
010	10	10	10	10	10	10
011	11	11	11	11	11	11
012	12	12	12	12	12	12
013	13	13	13	13	13	13
014	14	14	14	14	14	14
015	15	15	15	15	15	15
016	16	16	16	16	16	16
017	17	17	17	17	17	17
018	18	18	18	18	18	18
019	19	19	19	19	19	19
020	20	20	20	20	20	20
021	21	21	21	21	21	21
022	22	22	22	22	22	22
023	23	23	23	23	23	23
024	24	24	24	24	24	24
025	25	25	25	25	25	25
026	26	26	26	26	26	26
027	27	27	27	27	27	27
028	28	28	28	28	28	28
029	29	29	29	29	29	29
030	30	30	30	30	30	30
031	31	31	31	31	31	31
032	32	32	32	32	32	32
033	33	33	33	33	33	33
034	34	34	34	34	34	34
035	35	35	35	35	35	35
036	36	36	36	36	36	36
037	37	37	37	37	37	37
038	38	38	38	38	38	38
039	39	39	39	39	39	39
040	40	40	40	40	40	40
041	41	41	41	41	41	41
042	42	42	42	42	42	42
043	43	43	43	43	43	43
044	44	44	44	44	44	44
045	45	45	45	45	45	45
046	46	46	46	46	46	46
047	47	47	47	47	47	47
048	48	48	48	48	48	48
049	49	49	49	49	49	49
050	50	50	50	50	50	50

S25-S25

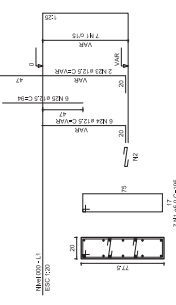

P22-P22



S18-S18 (Set 1#S12#S14#S19)

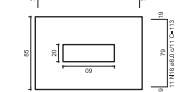

P18-P18

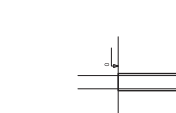

S18-S18

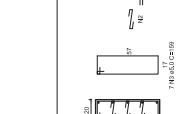

P18-P18

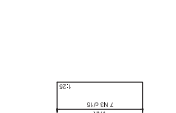

S20-S20

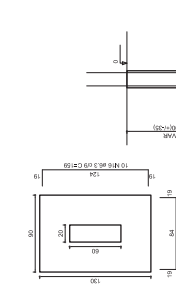

P23

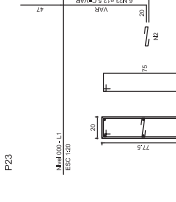

S23

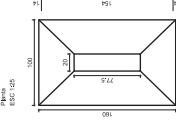

P1

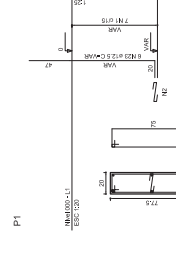

S1

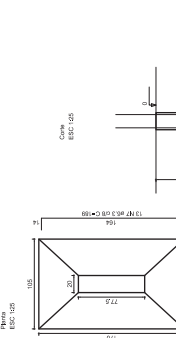

GOVERNO FEDERAL

BRASIL Ministério da Educação

FUNDE Fundo Nacional de Educação

PAIS RICO E PAIS SEM POBREZA

PROJETO PADRÃO - FNDE

MUNICÍPIO - UF:	
PROPRIETÁRIO:	CREA
ENGENHEIRO:	
PROPRIETÁRIO:	
RESP. TÉCNICO:	
DEFO:	CREA
OBSERVAÇÕES:	

COORDENADOR: ...

PROFESSOR RESPONSÁVEL: ...

FORMADO: ...

QUADRA COBERTA

PROJETO ESTRUTURAL

ESTRUTURA DE CONCRETO

SAPATAS

EST

FRANCA: 09/11

RELAÇÃO DO V1 V2 V3 V4 V5 V6 V7 V8 V9 V10 V11 V12

QUANT.	UNID.	ESPEC.	PREÇO UNIT.	PREÇO TOTAL
2	M	6.21	2.200	4.400
1	M	6.33	2.200	2.200
4	M	6.31	2.200	8.800
7	M	6.52	2.200	15.400
2	M	6.50	2.200	4.400
6	M	6.51	2.200	13.200
8	M	6.53	2.200	17.600
12	M	6.54	2.200	26.400
17	M	6.55	2.200	37.400
12	M	6.56	2.200	26.400
10	M	6.57	2.200	22.000
12	M	6.58	2.200	26.400
10	M	6.59	2.200	22.000
10	M	6.60	2.200	22.000
12	M	6.61	2.200	26.400
10	M	6.62	2.200	22.000
10	M	6.63	2.200	22.000
10	M	6.64	2.200	22.000
10	M	6.65	2.200	22.000
10	M	6.66	2.200	22.000
10	M	6.67	2.200	22.000
10	M	6.68	2.200	22.000
10	M	6.69	2.200	22.000
10	M	6.70	2.200	22.000
10	M	6.71	2.200	22.000
10	M	6.72	2.200	22.000
10	M	6.73	2.200	22.000
10	M	6.74	2.200	22.000
10	M	6.75	2.200	22.000
10	M	6.76	2.200	22.000
10	M	6.77	2.200	22.000
10	M	6.78	2.200	22.000
10	M	6.79	2.200	22.000
10	M	6.80	2.200	22.000
10	M	6.81	2.200	22.000
10	M	6.82	2.200	22.000
10	M	6.83	2.200	22.000
10	M	6.84	2.200	22.000
10	M	6.85	2.200	22.000
10	M	6.86	2.200	22.000
10	M	6.87	2.200	22.000
10	M	6.88	2.200	22.000
10	M	6.89	2.200	22.000
10	M	6.90	2.200	22.000
10	M	6.91	2.200	22.000
10	M	6.92	2.200	22.000
10	M	6.93	2.200	22.000
10	M	6.94	2.200	22.000
10	M	6.95	2.200	22.000
10	M	6.96	2.200	22.000
10	M	6.97	2.200	22.000
10	M	6.98	2.200	22.000
10	M	6.99	2.200	22.000
10	M	7.00	2.200	22.000

RESUMO DO V10

ITEM	QTD	UNID.	PREÇO UNIT.	PREÇO TOTAL
1.000	100	M	2.200	220.000
1.001	50	M	2.200	110.000
1.002	100	M	2.200	220.000
1.003	100	M	2.200	220.000
1.004	100	M	2.200	220.000
1.005	100	M	2.200	220.000
1.006	100	M	2.200	220.000
1.007	100	M	2.200	220.000
1.008	100	M	2.200	220.000
1.009	100	M	2.200	220.000
1.010	100	M	2.200	220.000
1.011	100	M	2.200	220.000
1.012	100	M	2.200	220.000
1.013	100	M	2.200	220.000
1.014	100	M	2.200	220.000
1.015	100	M	2.200	220.000
1.016	100	M	2.200	220.000
1.017	100	M	2.200	220.000
1.018	100	M	2.200	220.000
1.019	100	M	2.200	220.000
1.020	100	M	2.200	220.000

G.O. BRASIL
 Ministério da Educação
FUNDE Fundação Nacional do Ensino
 PAÍS RICO E PAÍS SEM POBREZA

PROJETO PADRÃO - FNDE

MUNICÍPIO - UF:
 PROPRIETÁRIO:
 ENDEREÇO:

PROPRIETÁRIO:
 RESP. TÉCNICO:
 DATA:
 CREA:
 RA:

OBSERVAÇÕES:

QUADRA COBERTA	
PROJETO ESTRUTURAL	
CONCRETO	ESTRUTURA DE CONCRETO
FORMAÇÃO	VIGAS - NÍVEL 0,00
PROPOSTA	ESTRUT. 11/25
REVISÃO	DATA ELABORAÇÃO
R.30	11/2011
FORMADO	PROPOSTA
PROJ. (RUI S.M.A.)	PROPOSTA
PROJ. (RUI S.M.A.)	PROPOSTA

EST 10/11

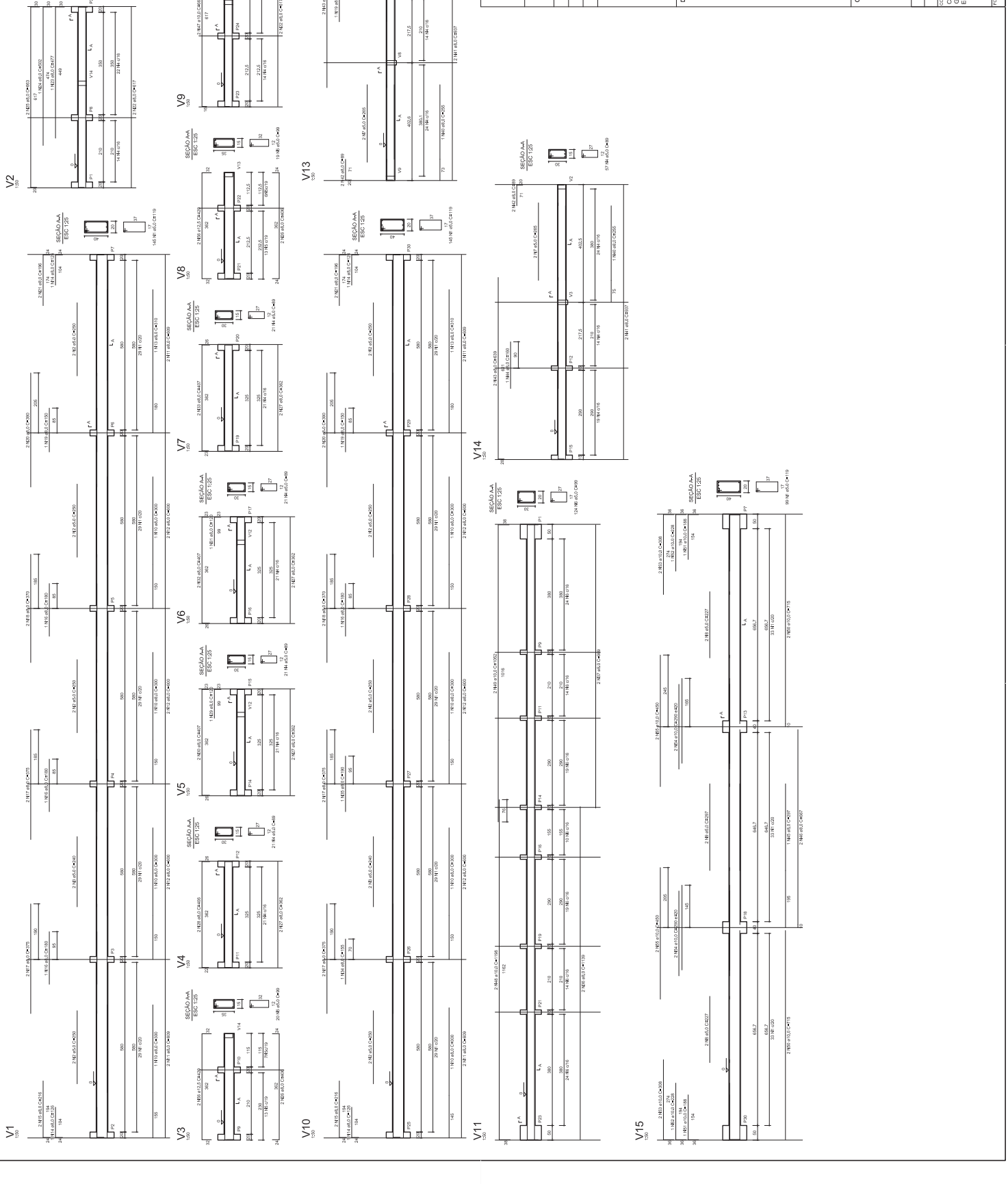

RELAÇÃO DOS VIGAS				QTD.	RELAÇÃO DE VIGAS
QTD.	DIÁM.	TIPO	COM.	RELAÇÃO DE VIGAS	QTD.
01	16	P	16	10	10
02	16	P	16	10	10
03	16	P	16	10	10
04	16	P	16	10	10
05	16	P	16	10	10
06	16	P	16	10	10
07	16	P	16	10	10
08	16	P	16	10	10
09	16	P	16	10	10
10	16	P	16	10	10
11	16	P	16	10	10
12	16	P	16	10	10
13	16	P	16	10	10
14	16	P	16	10	10
15	16	P	16	10	10
16	16	P	16	10	10
17	16	P	16	10	10
18	16	P	16	10	10
19	16	P	16	10	10
20	16	P	16	10	10
21	16	P	16	10	10
22	16	P	16	10	10
23	16	P	16	10	10
24	16	P	16	10	10
25	16	P	16	10	10
26	16	P	16	10	10
27	16	P	16	10	10
28	16	P	16	10	10
29	16	P	16	10	10
30	16	P	16	10	10

QTD.	TIPO	QTD.	TIPO	QTD.	TIPO
01	16	01	16	01	16
02	16	02	16	02	16
03	16	03	16	03	16
04	16	04	16	04	16
05	16	05	16	05	16
06	16	06	16	06	16
07	16	07	16	07	16
08	16	08	16	08	16
09	16	09	16	09	16
10	16	10	16	10	16

Área de forma total = 52,45 m²

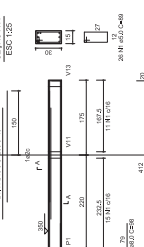
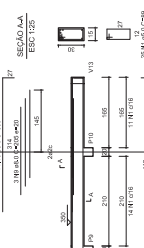
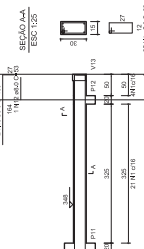
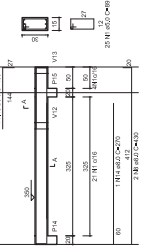
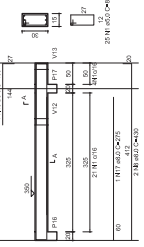
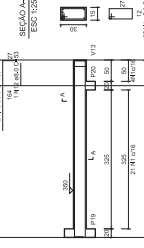
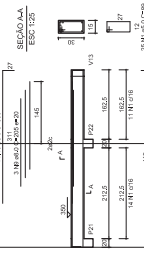

QTD.	TIPO	QTD.	TIPO	QTD.	TIPO
01	16	01	16	01	16
02	16	02	16	02	16
03	16	03	16	03	16
04	16	04	16	04	16
05	16	05	16	05	16
06	16	06	16	06	16
07	16	07	16	07	16
08	16	08	16	08	16
09	16	09	16	09	16
10	16	10	16	10	16
11	16	11	16	11	16
12	16	12	16	12	16
13	16	13	16	13	16
14	16	14	16	14	16
15	16	15	16	15	16
16	16	16	16	16	16
17	16	17	16	17	16
18	16	18	16	18	16
19	16	19	16	19	16
20	16	20	16	20	16
21	16	21	16	21	16
22	16	22	16	22	16
23	16	23	16	23	16
24	16	24	16	24	16
25	16	25	16	25	16
26	16	26	16	26	16
27	16	27	16	27	16
28	16	28	16	28	16
29	16	29	16	29	16
30	16	30	16	30	16

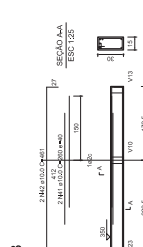
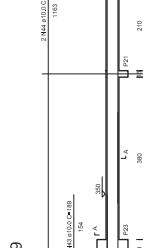
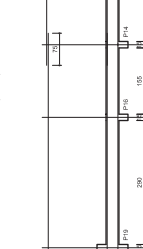
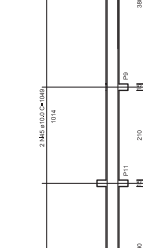
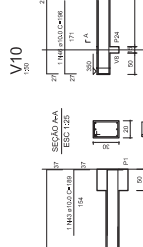
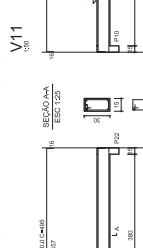
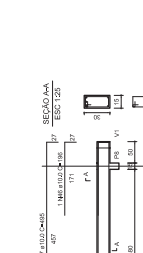

BRASIL Governo Federal
 Ministério da Educação
FUNDE Fundo Nacional de Educação
 PAÍS RICO E PAÍS SEM POBREZA

PROJETO PADRÃO - FNDE

MUNICÍPIO - UF:	
PROPRIETÁRIO:	
ENGENHEIRO:	
PROPRIETÁRIO:	
RESP. TÉCNICO:	
DLE/O:	CREA
RA:	

**QUADRA COBERTA
 PROJETO ESTRUTURAL**

ESTRUTURA DE CONCRETO
 VIGAS - NÍVEL 200

COORDENADOR: Eng.º Cristiano Pereira
 Chefe de Inspeção: Eng.º Genivaldo

FORMADO: 14/11/2004
 REVISADO: RJP
 REVISOR: 11/25
 FRANÇA: 11/11

OPERAÇÕES: